

Niniejszy rysunek jest własnością Interfit Sp. z o.o.. Jakikolwiek kopiowanie lub przekazywanie osobom trzecim bez naszej zgody jest zabronione.
 This drawing is property of Interfit Sp. z o.o.. Each duplication or passing on to third persons without our permission is forbidden and will be pursued.

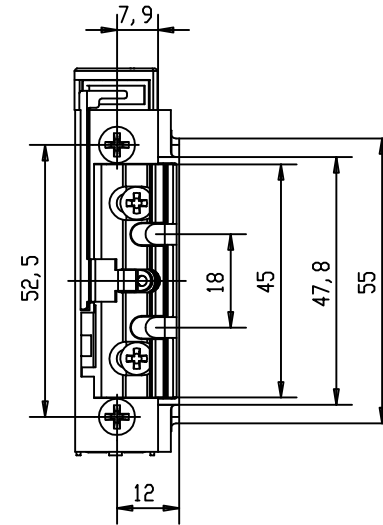
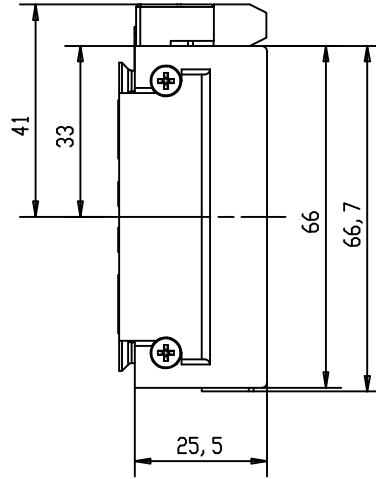
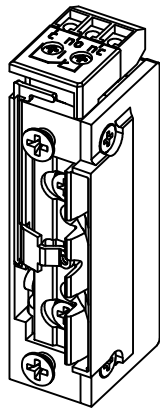
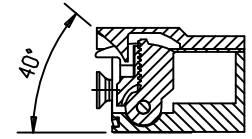
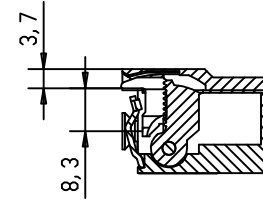
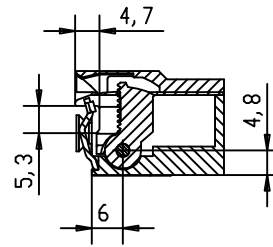
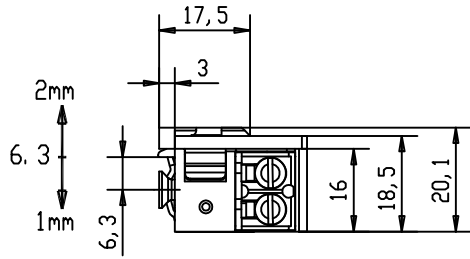
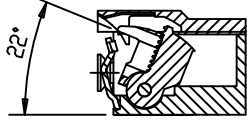
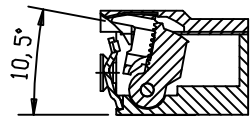

www.interfit.pl

INTERFIT Sp. z o.o.
 ul. Biskupia 46
 04-216 Warszawa

<p>Seria:</p>	<p>Systemy kontroli dostępu</p>	
<p>Dystrybutor:</p>	<p>Interfit Sp. z o.o.</p>	<p>Wymiary [mm]</p>
<p>Elektrozaczep rewersyjny z funkcją monitoringu</p>		<p>nr. ID</p> <p>-----</p>